

# Literal Translations

**preparing literal, exact or mirror translations of  
patent documents**

By Martin Cross

[cross@PatentTranslations.com](mailto:cross@PatentTranslations.com)

Patent Translations Inc.

[www.PatentTranslations.com](http://www.PatentTranslations.com)

1-800-844-0494

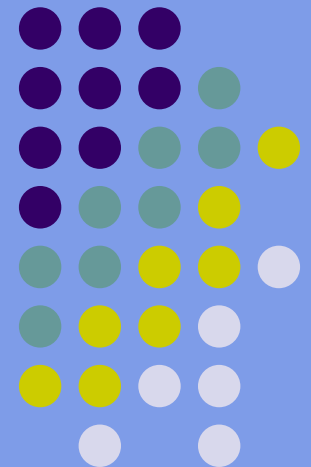

©Copyright: Patent Translations Inc. 2006.

Reproduction, distribution and commercial use without prior written consent are prohibited.

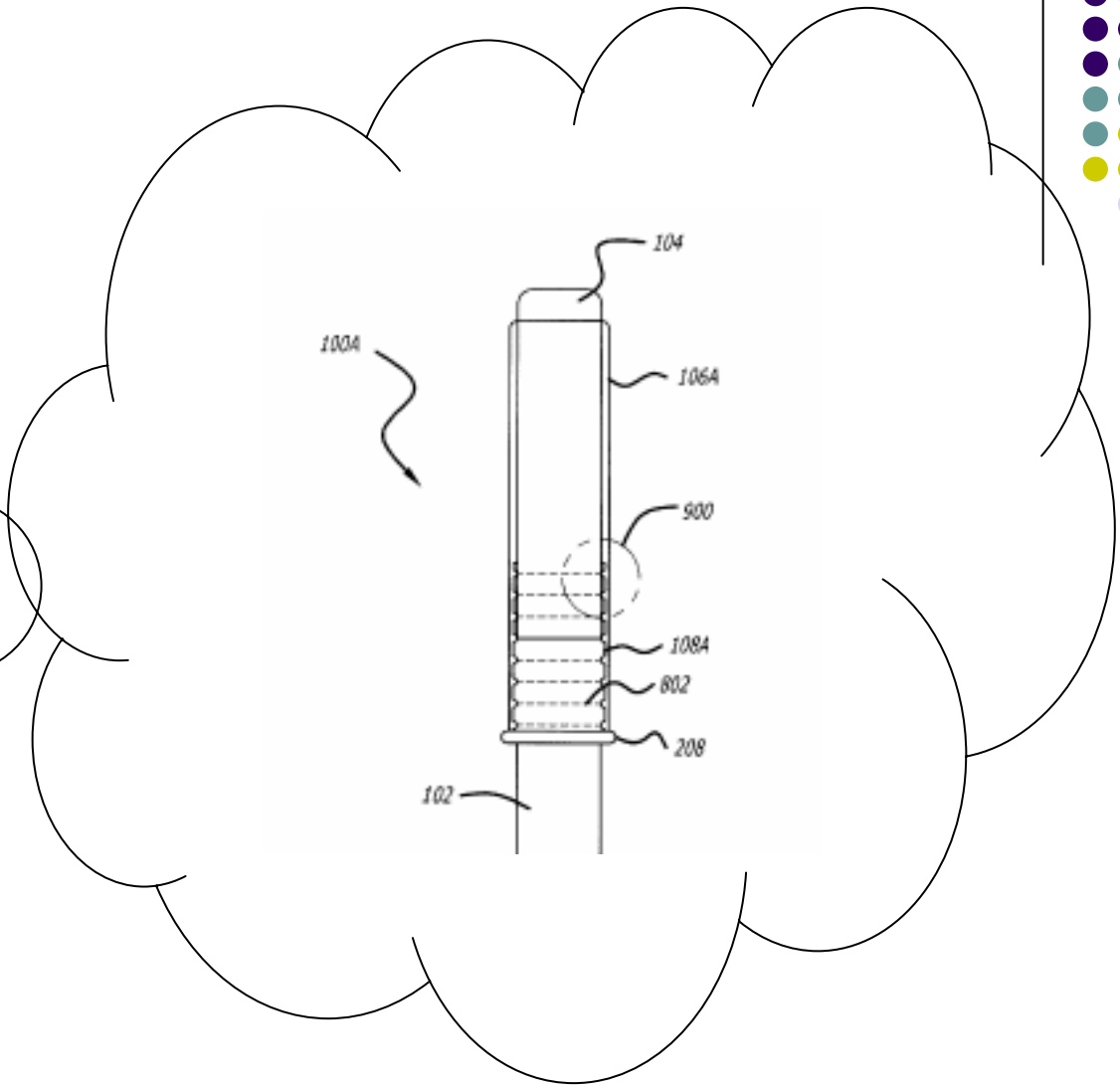

**Frank**

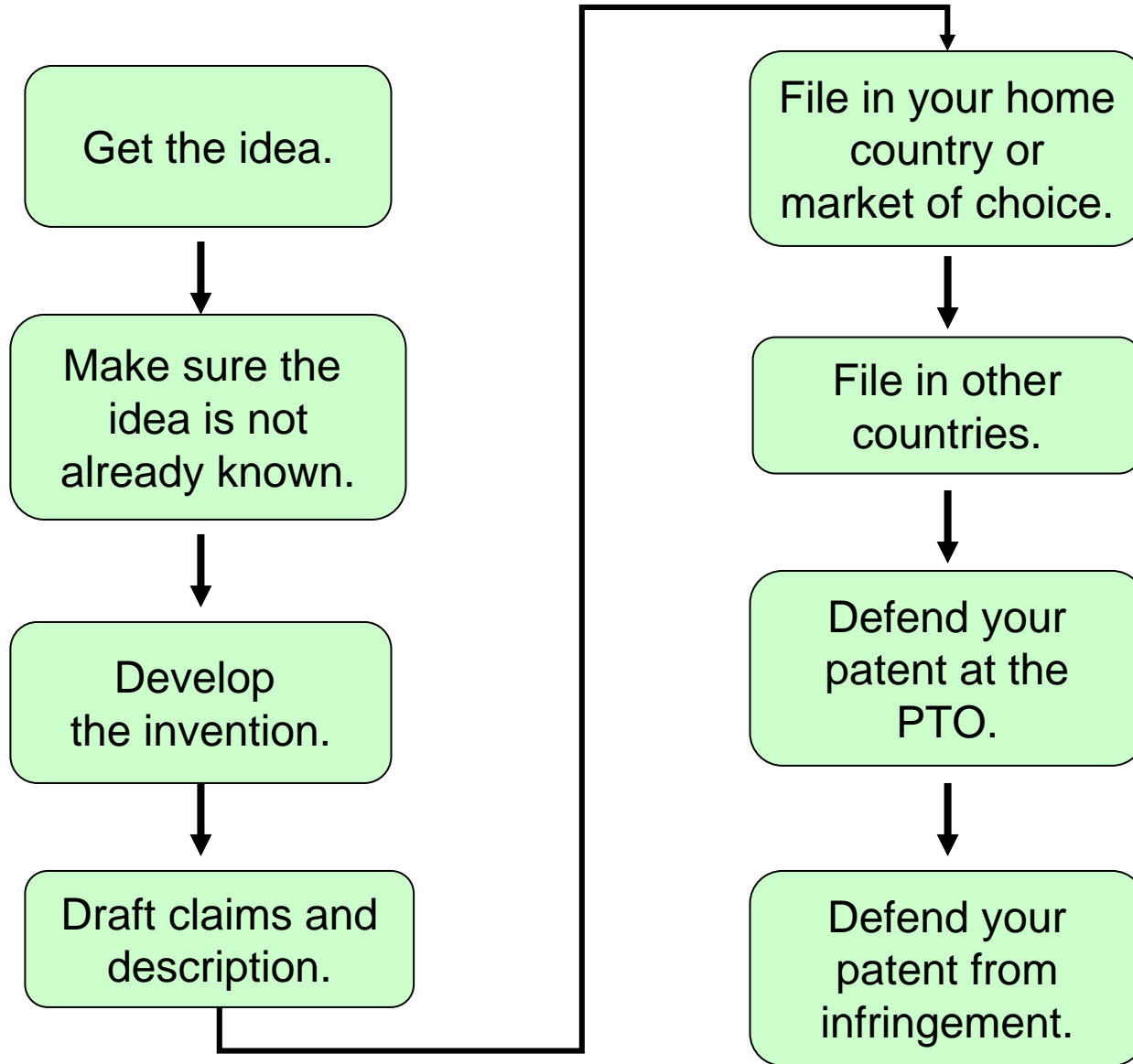

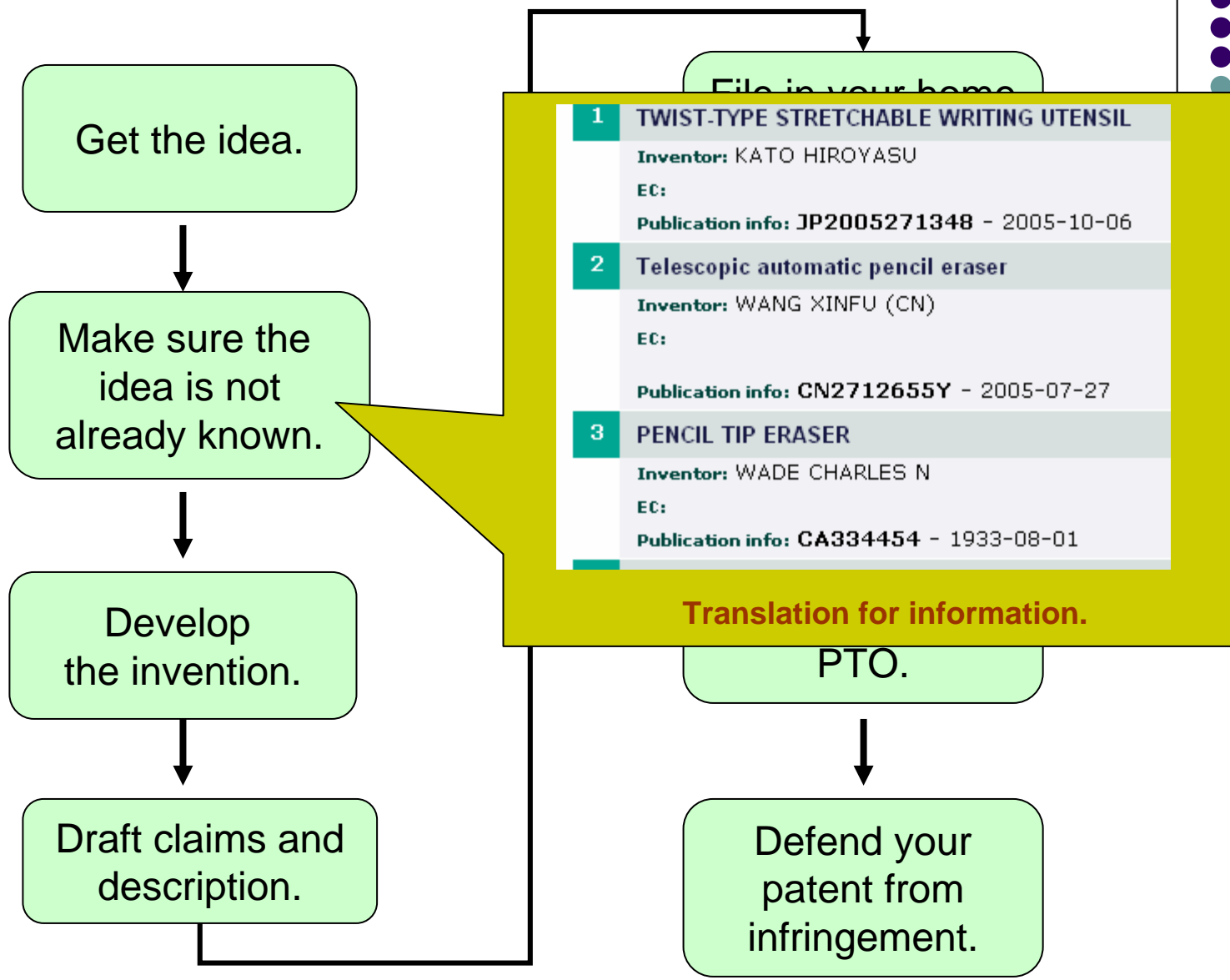
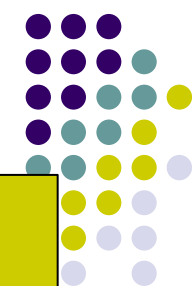



The cap comprises an aperture having a diameter that is greater than the diameter of the eraser, and is slidably engaged on the end of the pencil so as to support and protect the eraser.

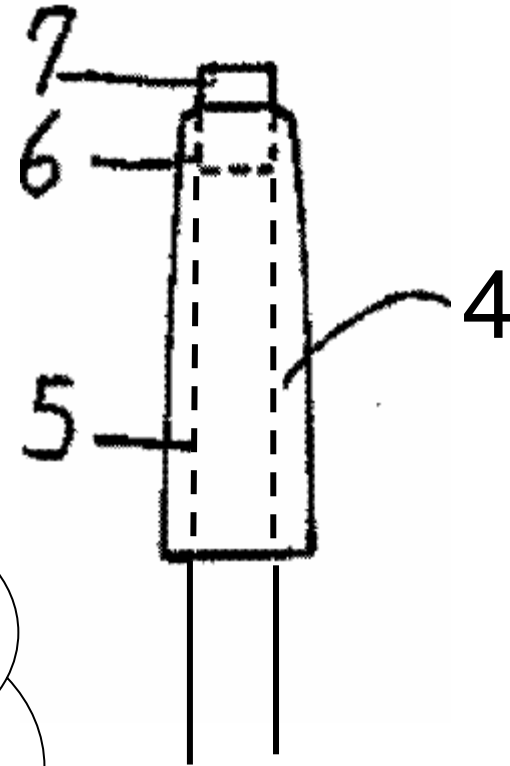

*The cap has a hole in it that is wider than the eraser, and it fits on the end of the pencil so as to protect the eraser.*

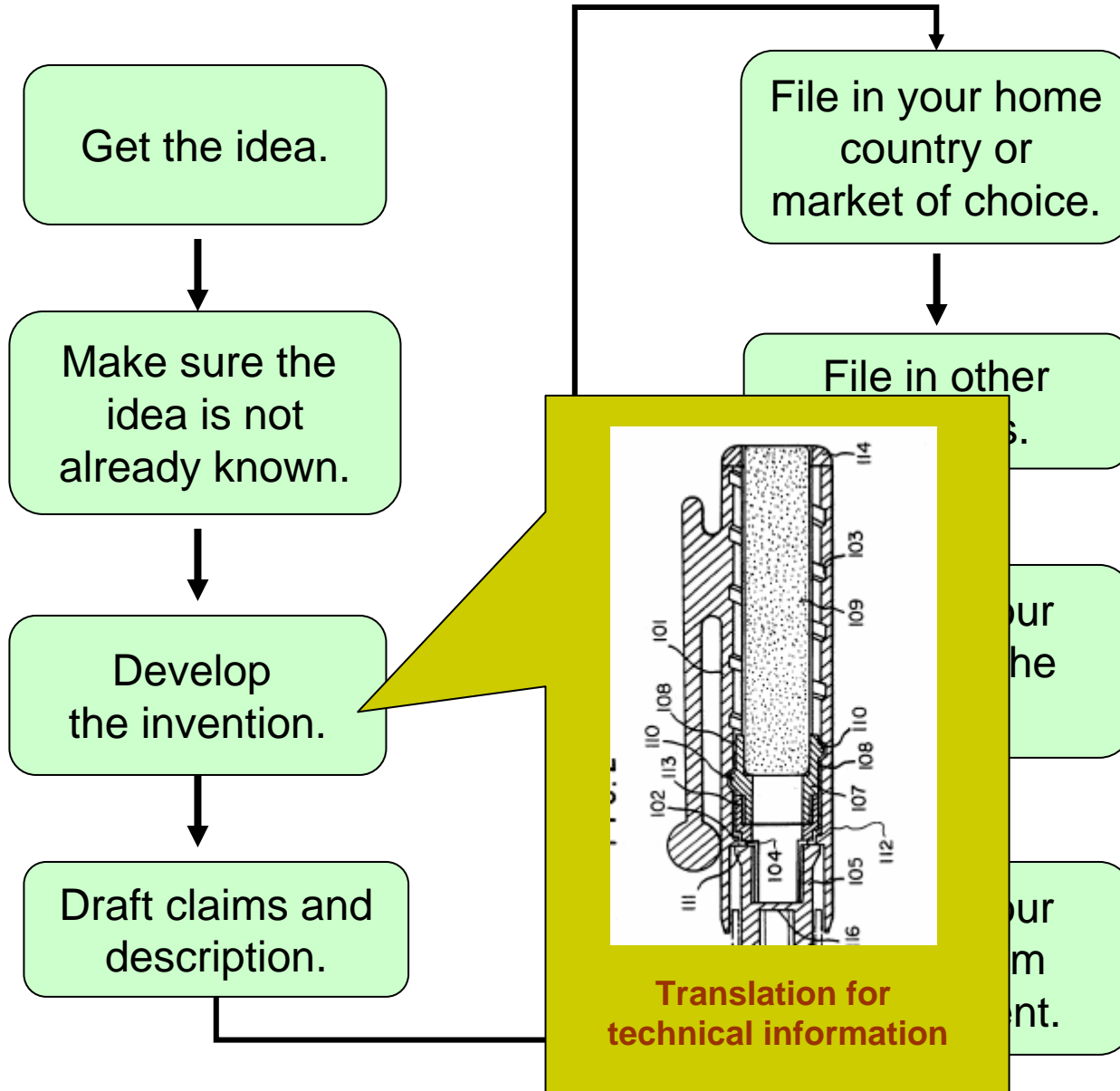

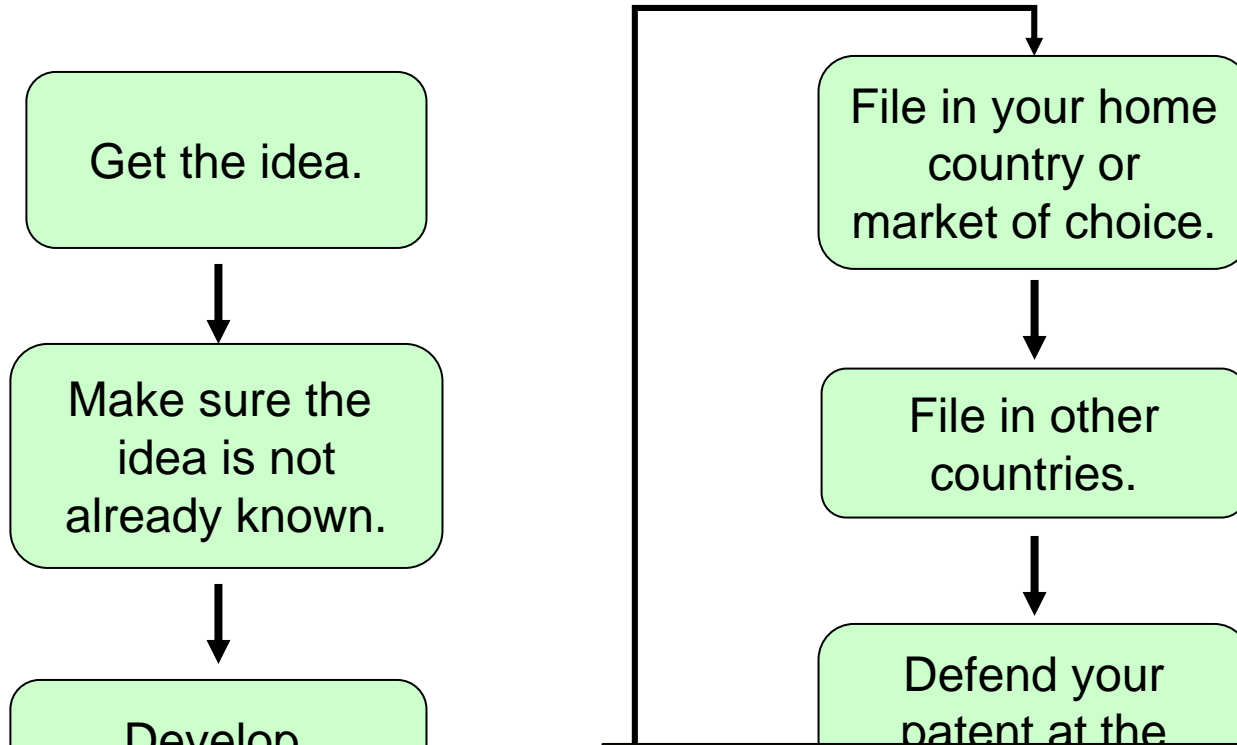

What is claimed is:  
1. A writing instrument comprising:  
a lead pencil having a first end and a second end;  
a ferrule coupled to the second end of the lead pencil, the ferrule having one or more slots in an outer surface;  
an elongated fixed eraser having a first end coupled to the ferrule and a second end free to erase pencil marks;  
and  
an eraser sleeve moveably coupled to the one or more slots of the ferrule, the eraser sleeve covering an unused portion of the elongated fixed eraser and exposing an erasing portion of the elongated fixed eraser.

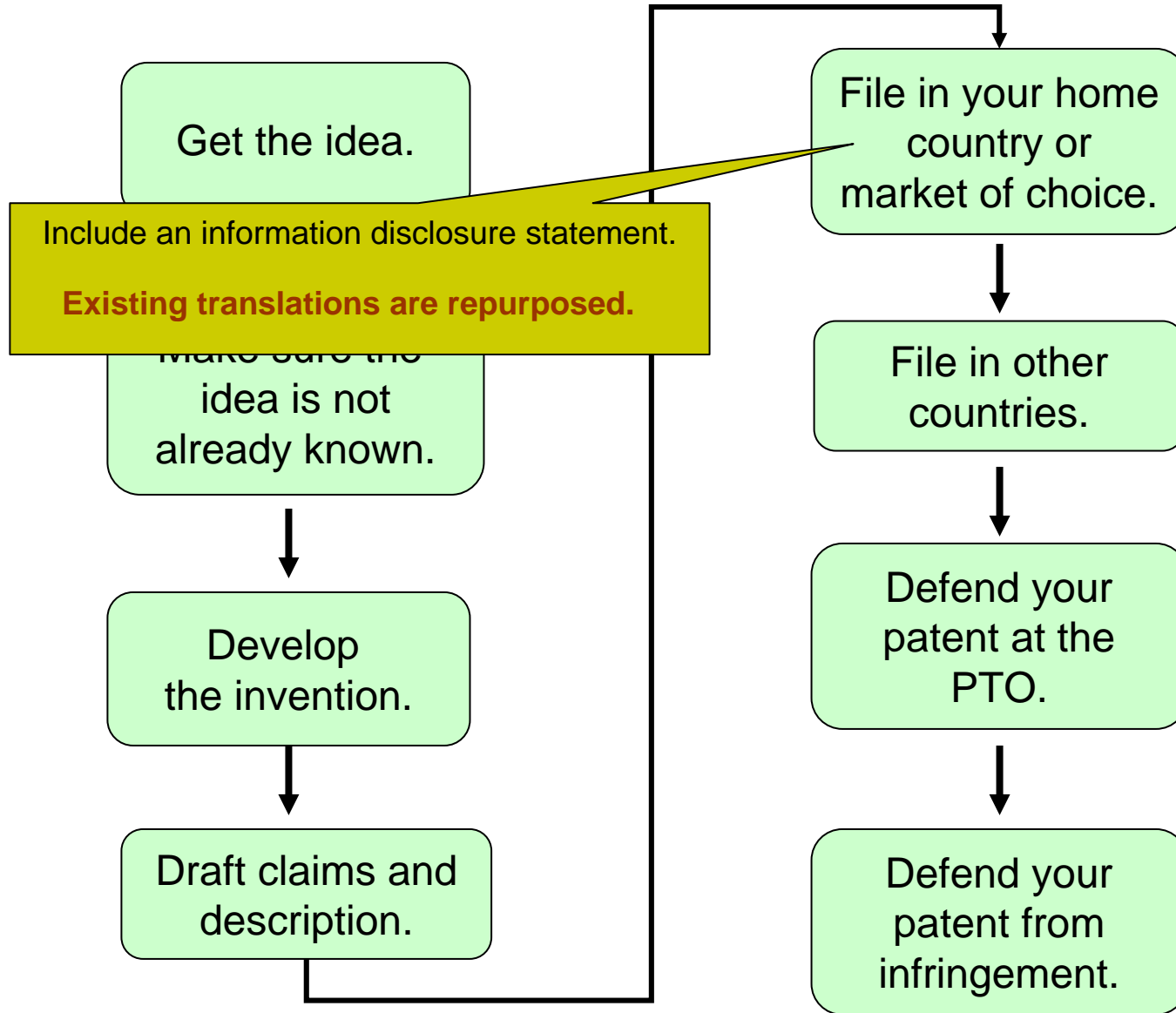
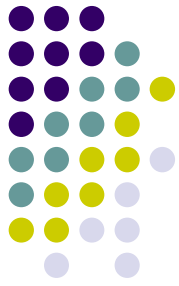



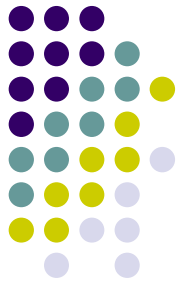

Get the idea.

File in your home country or market of choice.

<b>Patent Cooperation Treaty</b>	<b>Foreign Language Filing</b>	<b>Paris Convention</b>
Literal	Literal	Restructured

File in other countries.

Defend your patent at the PTO.

Defend your patent from infringement.

Develop the invention.

Draft claims and description.

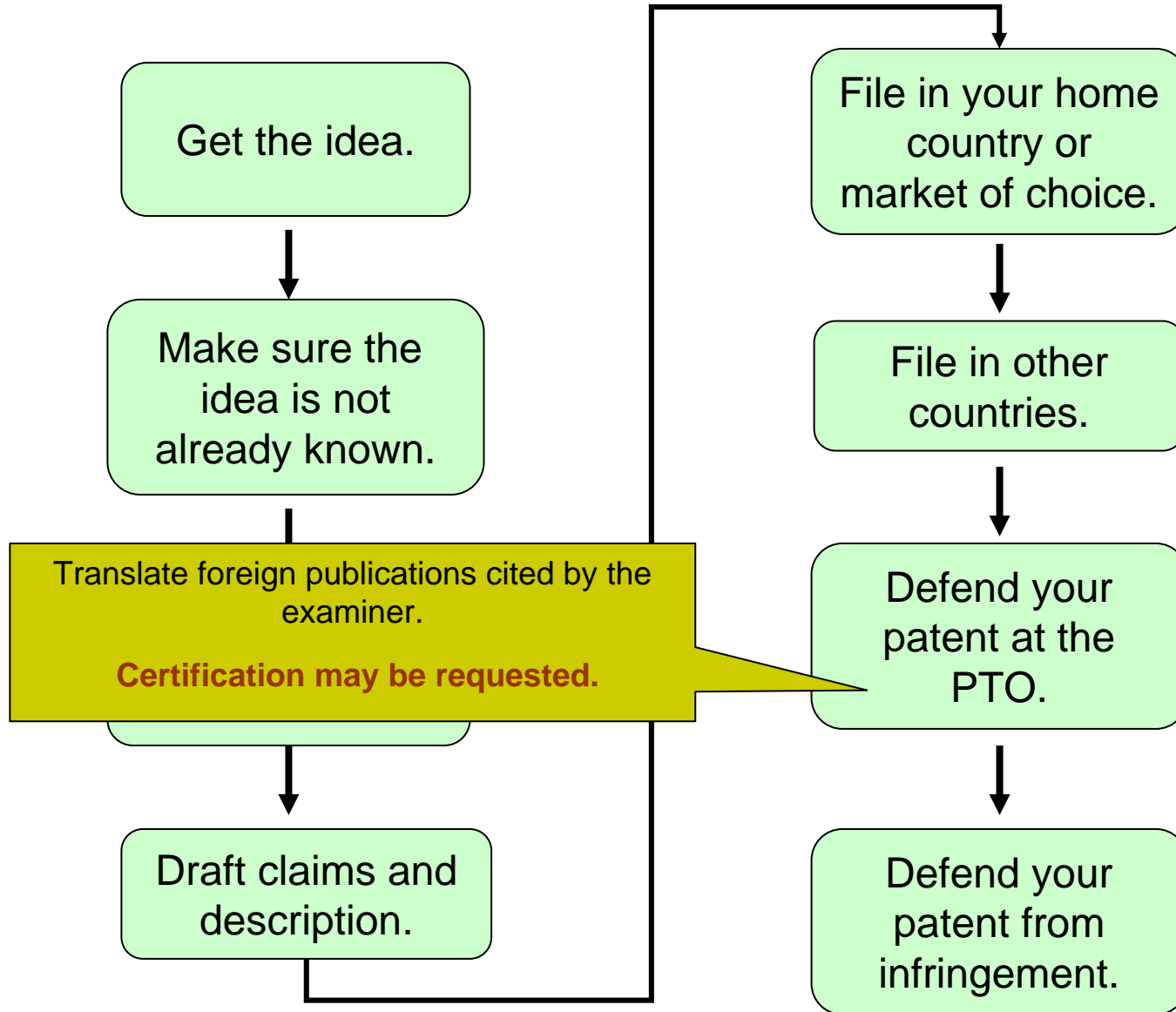
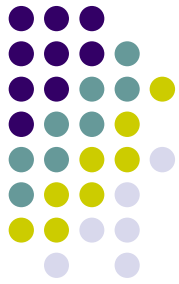

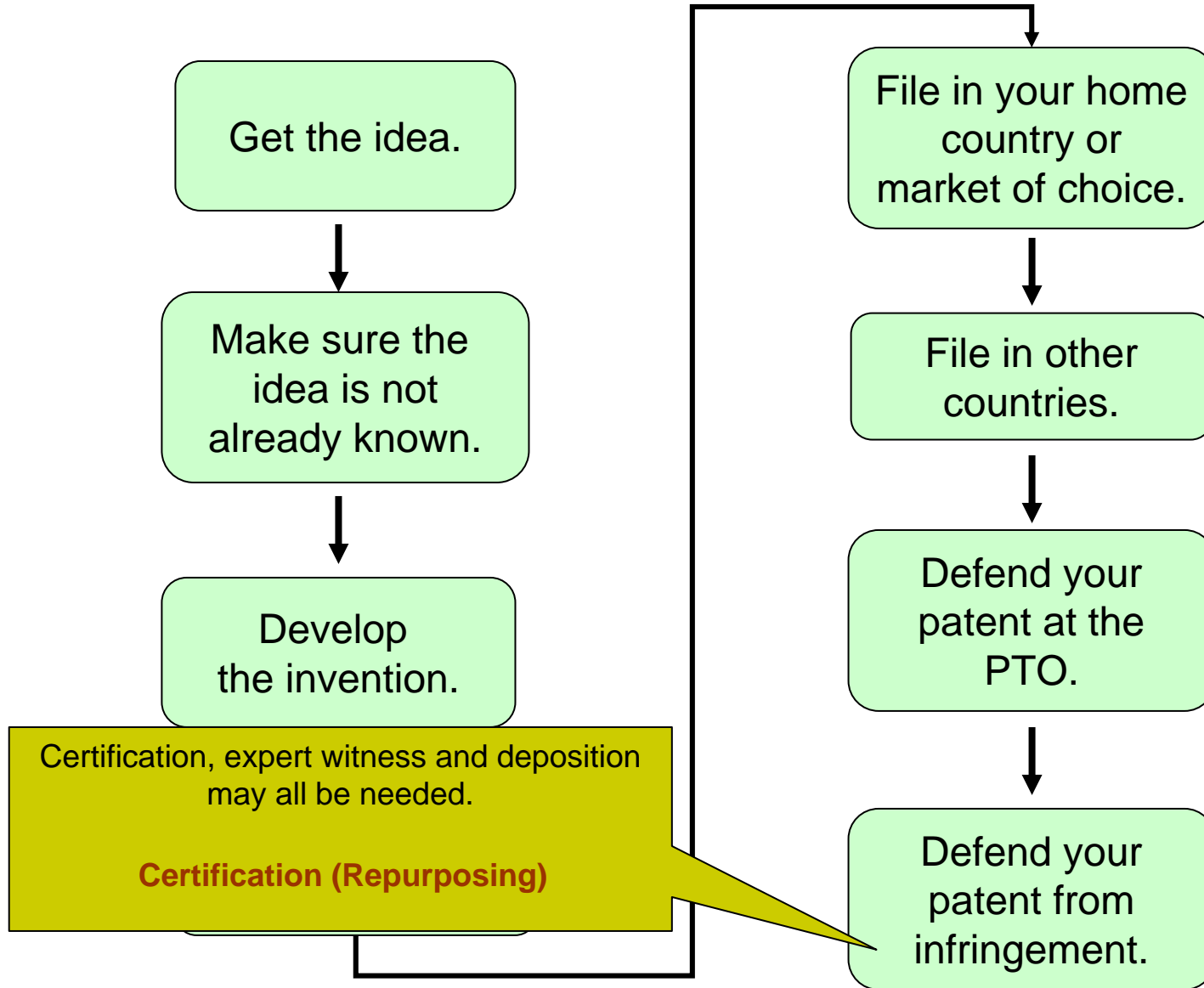



~~The cap has a hole in it that is wider than the eraser, and it fits on the end of the pencil so as to protect the eraser.~~

**The cap comprises an aperture having a diameter that is greater than the diameter of the eraser, and is slidably engaged on the end of the pencil so as to support and protect the eraser.**

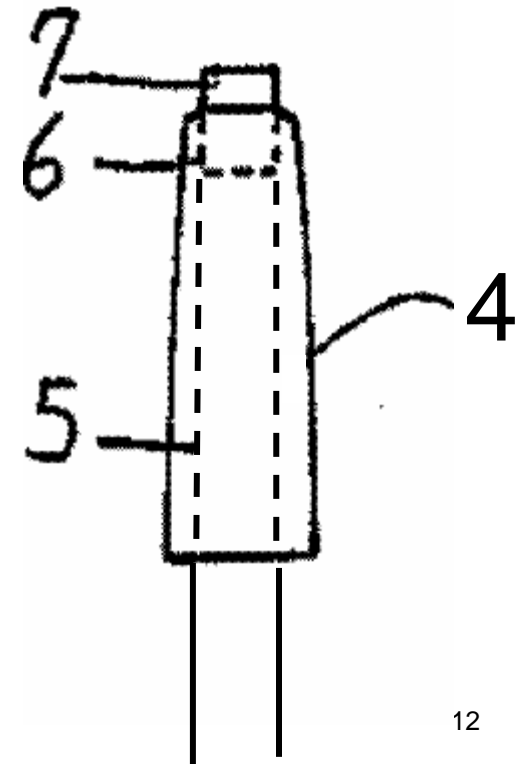



## **What literal patent translation is:**

An exact and accurate reproduction the entire content of the source text without embellishment or modification.

# What literal patent translation is not:



A lesson the syntax of the source language.  
(Formal Equivalence)

Bonjour! Je m'appelle Martin et je suis traducteur.

**Hello! I call myself Martin and I am translator.**

**Hi! My name is Martin and I am a translator.**



# Basic Rules

1. Reproduce meaning
2. Reproduce register
3. Respect sentence breaks and carriage returns
4. Consistent vocabulary and phrasing
5. One-to-one correspondence between source and target
6. Appropriate annotation



# 1. Reproduce meaning

- To judge whether or not the target reproduces the meaning, you must understand the source.
- Formal equivalence must not obscure functional equivalence.





## 2. Reproduce register

- The translator should be invisible.
- To reproduce the register of a patent attorney, you must know what a patent attorney sounds like in the target language.

# 3. Respect sentence breaks and carriage returns



- Decisions about sentence and paragraph length have already been made by the source author.
- The semicolon is your friend.

# 4. Consistent vocabulary and phrasing



- It is important that the wording in the description be consistent with the claims.
- The need for consistency does not trump linguistic constraints.

# 5. One-to-one correspondence



La présente invention concerne un dispositif complémentaire au rideau de douche.

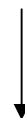
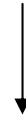

The present invention relates to an auxiliary device for a shower curtain.

4.1 Conservation of lexemes

4.2 Equivalent phrasing



Je m'appelle Martin et je suis traducteur.

Equivalent Phrasing



Conservation of Lexemes



**My name is Martin and I am a translator.**



# 4.1 What's a lexeme anyway?

- Lexemes are the basic units in “content words,” and have independent meaning.
- Function words are the grammatical glue that holds lexemes together.

For our purposes, we are going to say that lexemes include: nouns, verbs, adjectives, adverbs and numerals.

dog, gun, multitasking, run, implement, disassociate, fast, slowly, 150, five, ...

Function word include: articles, pronouns, prepositions, postpositions, conjunctions, auxiliary verbs, interjections, particles, and expletives.

him, she, it, they, that, of, on, under, before, thereafter, thereby, and, but, for, so, unless, because, is, may, can, should, will, wow, oh, to, even, there, be (*careful with a/the*) ...

# Spot the lexeme



The **invention relates generally** to the **field** of **writing instruments**.

The **casing** may **also be referred to** as a **barrel** or a **sheath**.

# Conserving lexemes

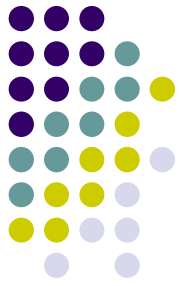

F	L	L	L	L (jump)	L	F	L	L
The	quick	brown	fox	jumped	over	the	lazy	dog.

- ✓ *Over the lazy dog, jumped the quick brown fox.*
- ✓ *The lazy dog was jumped over by the quick brown fox.*
- ✓ *The fox, which was quick and brown, jumped over the dog, which was lazy.*
- ✓ *The fox did jump, and did so over the dog, the fox being both quick and brown, while the dog was lazy.*



# Word and phrase order



- La présente invention est relative à un système de verrouillage des portières d'un véhicule automobile.
- The present invention relates to a system of locking of the doors of a motor vehicle.
- ✓ The present invention relates to a motor vehicle door locking system.
- ✓ The present invention relates to a door locking system for a motor vehicle.
- × The present invention relates to a system whereby the doors of a motor vehicle can be locked.



# Word and phrase order

- 窒素源としては、硫酸アンモニウム、塩化アンモニウム、尿素等、或いはこれらの混合物を使用することができる。
- For the nitrogen source, ammonium sulfate, ammonium chloride, urea and the like, or a mixture thereof, can be used.
- ✓ Ammonium sulfate, ammonium chloride, urea and the like, or a mixture thereof, can be used as the nitrogen source.
- × The nitrogen source can be chosen from ammonium sulfate, ammonium chloride, urea and the like, or a mixture thereof.

# Parts of speech



- Dieses Mittel wurde auf eine belichtete und ausgewaschene Photopolymer-Hochdruckplatte gesprüht ...
- This product was sprayed on a light-exposed and rinsed-off photopolymer letterpress printing plate ...
- ✓ This product was sprayed on a photopolymer letterpress printing plate, which had been exposed to light and rinsed-off ...
- × After preparing a photopolymer letterpress printing plate by exposing it to light and rinsing it off, the product was sprayed on ...



# Parts of speech

- La présente invention propose un système qui permette une resynchronisation fiable et économique entre émetteur et récepteur.
- The present invention proposes a system which allows a reliable and economic resynchronization between transmitter and receiver.
- ✓ The present invention proposes a system that allows the transmitter and the receiver to be resynchronized reliably and economically.
- × The present invention proposes a reliable and economical system for resynchronizing the transmitter and the receiver.

## 4.2 What is Equivalent Phrasing?



Equivalent phrasing is using a phrase or a term in the target text that comprises different lexemes from those in the source text, but which is the functionally equivalent to a phrase or a term in the source text.

# When to use Equivalent Phrasing



- When the equivalence is very well established (usually, but not always, when the equivalence is listed in a dictionary)
- When conserving the source lexemes would lead to undue confusion, or highly unnatural style



# Established Equivalents

- l'homme du métier  
man of the trade
- **those skilled in the art**
  
- 特許請求の範囲  
Scope of the Patent Claims
- **Claims**



# Avoiding Confusion

- ...電源の切り忘れを防止し得る。  
... it is possible to prevent forgetting to turn the power off  
... it is possible to prevent [people from] forgetting to turn the power off
- ...it is possible to prevent the power from being accidentally left on.





# Appropriate annotation

- Use square brackets to indicate added text.
- Use footnotes, or italics within square brackets, to add comments.
- Use raised numbers in parenthesis to reference amendments.



# Adding lexemes

- ローラの回転角に応じた個数の信号を発生する手段
- means for generating a number of signals corresponding to the rotational angle of the roller
- ✓ means for generating a number of signal [pulses] corresponding to the rotational angle of the roller
- × means for generating a number of signal [pulses] corresponding to [the amount by which] the roller [has been rotated]



# Indicating problems

- Transmission s'effectue de la clé 20 au dispositif d'identification 20.
- ✓ Transmission is made from the key 20 [*sic*] to the identification device 20.
- × Transmission is made from the key [30] to the identification device 20.



# Difficult to translate typos

- ...同一部分には同一番号を付して詳細な説明は商略する。
- × ...identical parts are given identical numerals and detailed descriptions thereof are the subject of a business plan [sic].
- ✓ ...identical parts are given identical numerals and detailed descriptions thereof are omitted<sup>1</sup>.

---

1: *There is a typographical error in the original Japanese text. –trans.*



# Amendments

## [Amendment to Proceedings]

...

## [Content of the Amendments]

1. On line 3 of page 7, “plastic knife” is amended to “polypropylene knife”.

The invention relates to a <sup>(1)</sup>plastic knife.

# When are literal translations required?



- for legal information (favor CL)

- for prior art research
- when writing an opinion or responding to an office action
- when preparing a case for litigation
- when developing an R&D strategy

- for PCT filing (favor EP)

- to enter the national phase in the US and other countries

- for foreign language filing (favor CL)

- as a follow through to filing at the USPTO in a language other than English

- for evidence (favor CL)

- to invalidate or defend against invalidation at the PTO or in court
- to prove priority

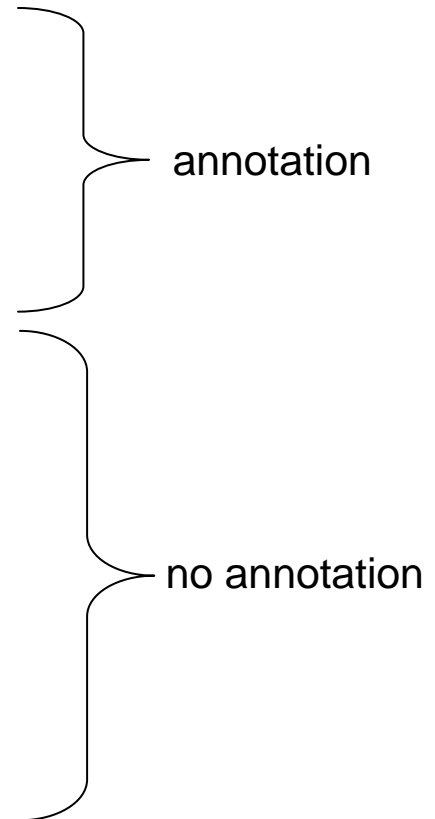



# References

- *Landis on Mechanics of Patent Claim Drafting*, by Robert C. Faber. (The patent drafters bible.)
- ATA's *Japanese Patent Translation Handbook*. (Invaluable for J>E Translators. To order, go to [www.atanet.org/publications/index.php](http://www.atanet.org/publications/index.php).)
- *How to Write a Patent Application*, by Jeffrey G. Sheldon (An excellent nuts and bolts guide.)
- *Inventor's Guide to Successful Patent Applications*, by Thomas E. Deforest. (Short, inexpensive and to the point.)
- Paris Convention  
[www.wipo.int/treaties/en/ip/paris/index.html](http://www.wipo.int/treaties/en/ip/paris/index.html)
- Patent Cooperation Treaty  
[www.uspto.gov/web/offices/pac/mpep/documents/appxt.htm](http://www.uspto.gov/web/offices/pac/mpep/documents/appxt.htm)
- U.S. Patent and Trademark Office  
[www.uspto.gov](http://www.uspto.gov)
- *United States Manual of Patent Examining Procedure*  
[www.uspto.gov/web/offices/pac/mpep/index.html](http://www.uspto.gov/web/offices/pac/mpep/index.html)
- World Intellectual Property Organization  
[www.wipo.org](http://www.wipo.org)